

The logo for INTINOR, featuring the letters I, N, T, I, N, O, R in a bold, sans-serif font. The letter 'I' has a green vertical bar to its left, and the letter 'R' has a red vertical bar to its right. The logo is set against a white rectangular background.

INTINOR

INTINOR

#MADEINSWEDEN

Eurovision enhanced RTP over SRT

Roland Axelsson

Senior technical account manager

Bifrost Reliable Transport

Proprietary **point-to-point** transport protocol

- **Sender and receiver network bonding**
Ethernet + 3G/4G
- Error correction – FEC and ARQ
- **New: Ultra-low latency (<500ms)**
- Adaptive bitrate and resolution
- Redundant audio
- Cost management

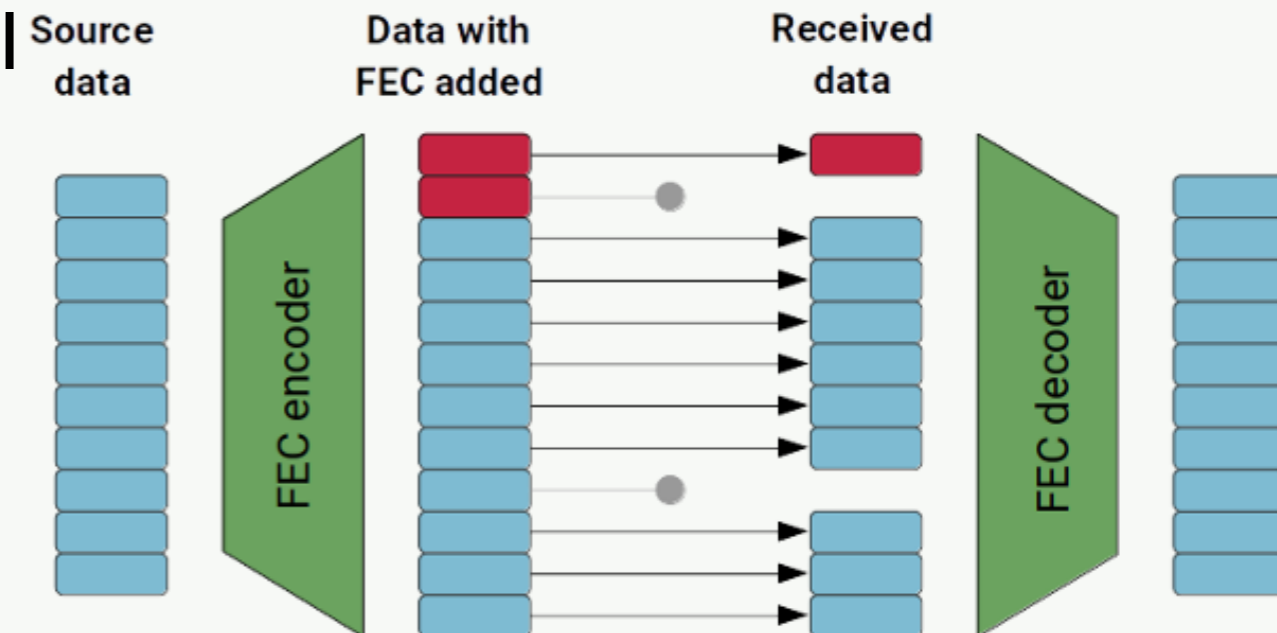

Direkt link (encoder)

SDI in from somewhere



Direkt router

SDI out / in



*Multiple protocols including
SRT, RIST, RTMP, RTSP, HLS, RTP, RTP+FEC, TCP*

Eurovision enhanced RTP over SRT in combination with SMPTE 2022-7

Why?

Make it possible to get a redundant stream from a combination of

1. Internet 1 (using SRT) + Internet 2 (using SRT)
2. Internet (using SRT) + Dark fiber
3. Internet (using SRT) + Satellite

SRT has something called “path redundancy” but it's only supported by very few vendors and it only covers above use case 1.

What is SRT?

- Open protocol to transport anything live
- Error correction – FEC (redundant data) and ARQ (retransmission)
- Mostly used for sending MPEG-TS, but can actually send anything

What is RTP?

- Adds a header with sequence number and timestamps

What is SMPTE 2022-7

- Seamless Protection Switching of RTP Datagrams
(receive from multiple redundant paths)

SMPTE 2022-7

- Decode from redundant streams

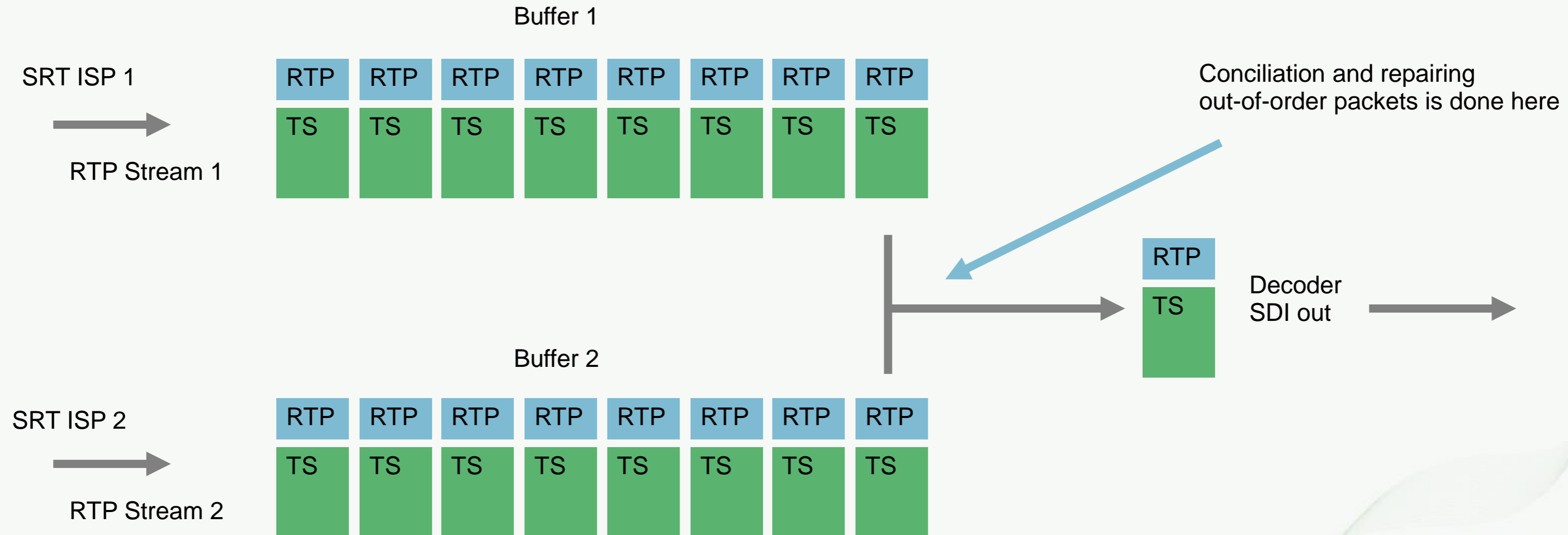

Eurovision enhanced RTP over SRT

Send redundant SRT streams using two different ISP from two different locations

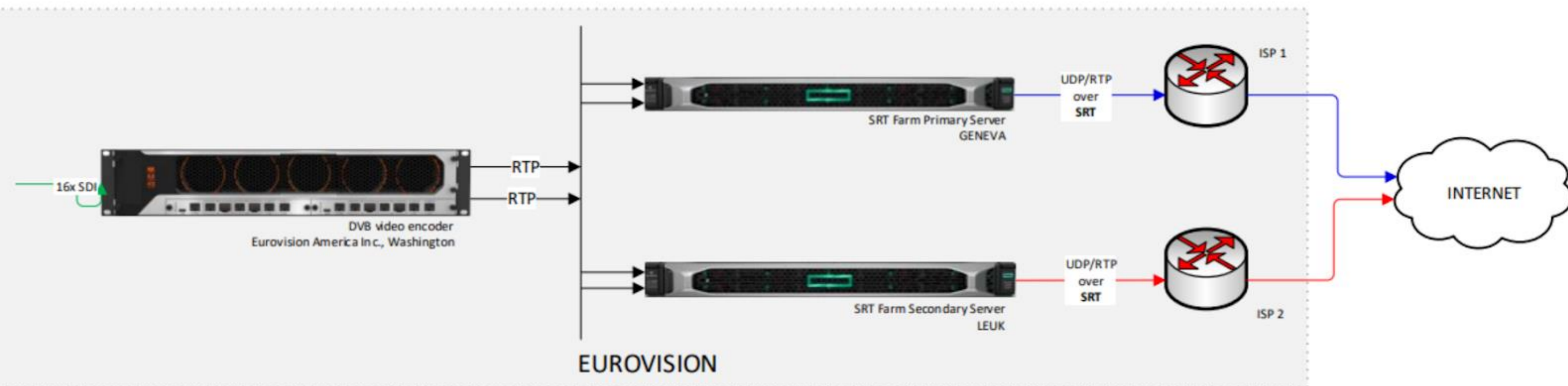

Eurovision enhanced RTP over SRT

Send redundant SRT streams using two different ISP from two different locations

16x SDI in
→



Supported on Intinor Direkt link from September 2023

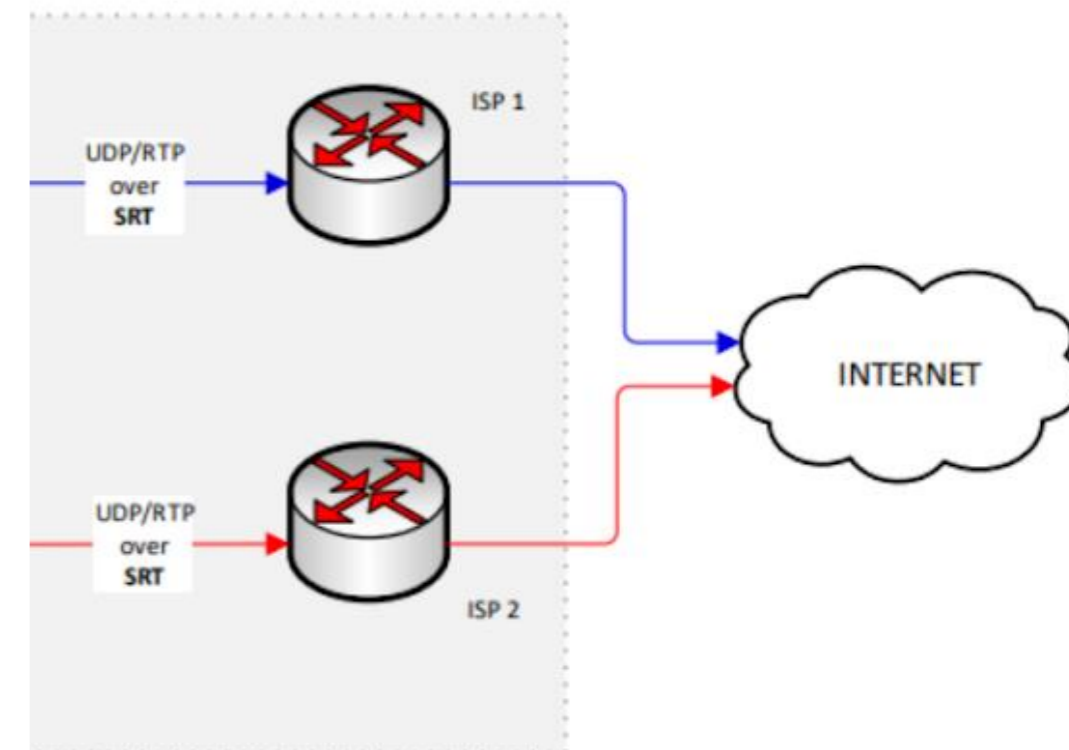

Eurovision enhanced RTP over SRT

Receive redundant streams

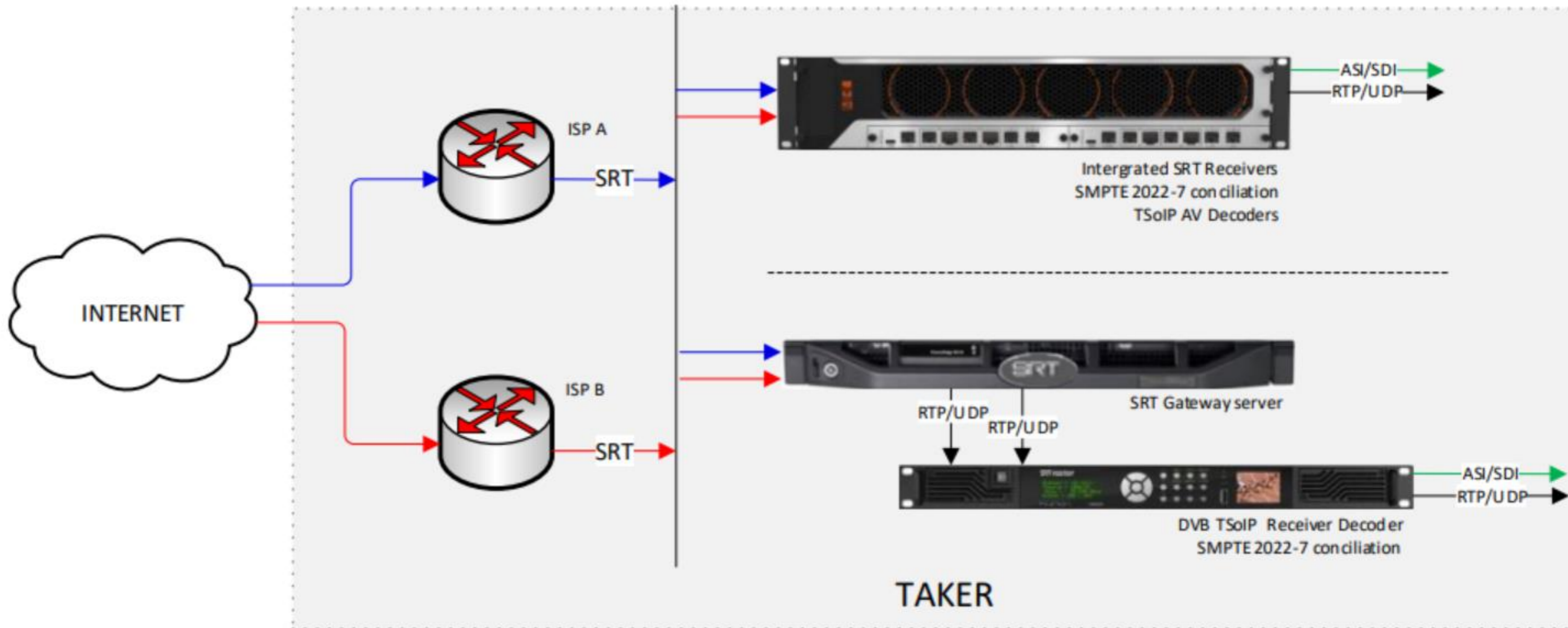

Eurovision enhanced RTP over SRT

Receive redundant streams

Intinor as a SRT gateway is available

now

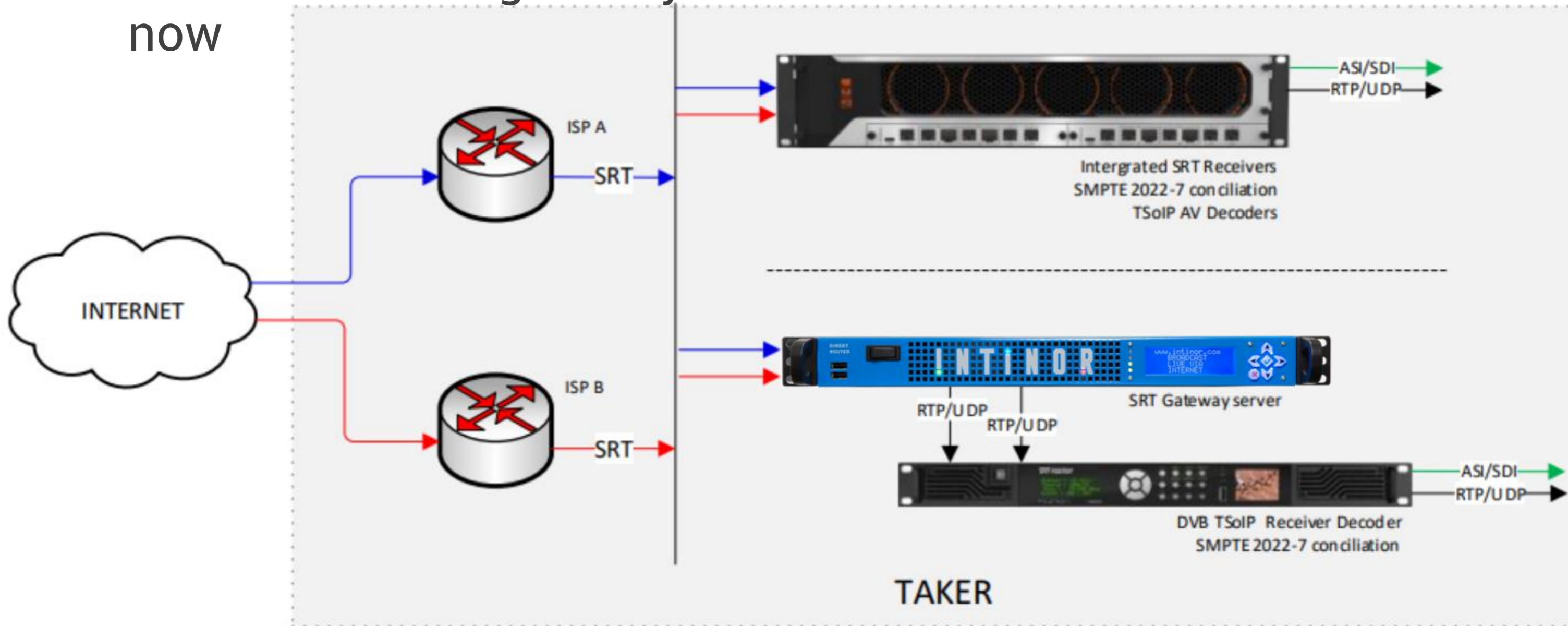

Eurovision enhanced RTP over SRT

Receive redundant streams –
SMPTE 2022-7 on Direkt router December 2023

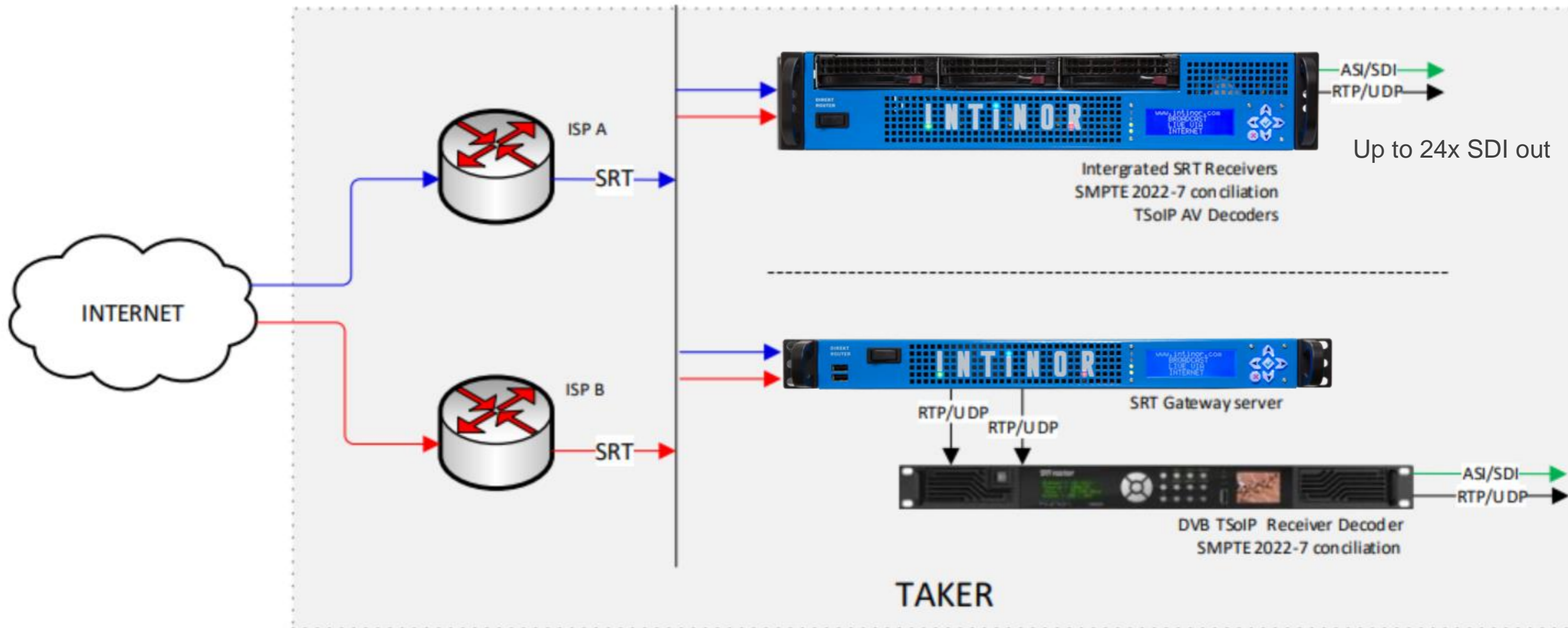

Bottom line:

Sending video over Internet can be as robust or even more robust compared to a single fiber or a single satellite.

Just a lot more cost efficient.

But make sure to use redundancy for both

- Internet connections (most important) and
- Equipment

INTINOR

SOLUTIONS FOR LIVE VIDEO OVER PUBLIC INTERNET



**Intinor aims to deliver
the best solution
for live video over public
internet!**



INTINOR

QUESTIONS?
www.intinor.com